



**METAL DETECTOR**  
**Alter71**



**USER'S MANUAL**

## **DEAR USER!**

Thank you for purchasing this product. This detector has been designed with the latest technology to allow you to make the most of your passion, to discover the remains of the past.

We hope that the Alter71 meets all of your expectations during your adventures.

This manual will give you all the necessary information, so that you can quickly understand how the Alter71 works before going into the field.

Please take some time to get to know your detector, each day spent working with your detector will increase your knowledge, and steadily increase the effectiveness of your searches.

Please remember that while you are searching, you will be uncovering history. Do not destroy these unique remains in the process, take some time to get to know the law of your country and leave your search area clean and tidy.

Be an exemplary user of Alter71:

Do not use the detector in areas that are under archaeological protection or where an archaeological dig has been conducted.

Before entering private property, ask the owner for permission.

Do not make life harder for farmers or foresters by damaging crops or disturbing animals.

Do not leave a mess after yourself. Leave the place you have searched, in the same condition as when you arrived.

Refill all holes, take any rubbish with you and put it in the next rubbish bin you come across.

## TABLE OF CONTENTS

DETECTOR ASSEMBLY.....	3
BATTERY INSTALLATION.....	3
CONTROL PANEL.....	4
TURNING ON/OFF.....	4
GROUND BALANCE.....	4
DISPLAY.....	5
PROGRAM SELECTION.....	6
IDENTIFICATION.....	7
IDENTIFICATION GRAPH.....	7
SETTINGS AVAILABLE IN OPERATING MODE.....	8
SENSITIVITY.....	9
DISCRIMINATION.....	9
NOTCH.....	9
PINPOINT.....	10
OVERLOAD.....	10
MENU LAYOUT.....	11
MENU – ENGINE PAGE.....	12
Frequency.....	12
Hot rock.....	12
Reaction.....	13
Masking.....	13
MENU – AUDIO PAGE.....	14
Th Level.....	14
Th Tone.....	14
Th Sens.....	14
Th SAT.....	15
Audio Gain.....	15
Volume.....	15
Tones.....	15
Wireless.....	16
MENU – SCREEN PAGE.....	17
Backlight.....	17
ID Type.....	17
Time Hold.....	17
Language.....	17
DETECTOR'S CAPABILITIES.....	18
MODES OF OPERATION.....	19
MODES OF OPERATION AND SEARCHING.....	21
SEARCHING – USEFUL ADVICE.....	22
NOTES FOR MAINTENANCE.....	23
PROGRAMS SETTINGS.....	23
EU DECLARATION OF CONFORMITY.....	25

## DETECTOR ASSEMBLY

The detector assembly is simple and requires no tools, a properly assembled detector is shown on the front cover of the user's manual. Before assembling the stems, make sure the stem lock is unlocked by rotating it as shown in the picture. Next push the spring buttons in and insert one stem into the other. Release the buttons and they will lock in the holes. Next secure the stem lock by turning it the other way until it is hand tight. Do not over tighten the locks or the screw securing the search coil. Wind the coil cable firmly around the stems, see the photo on the front page for best practice.

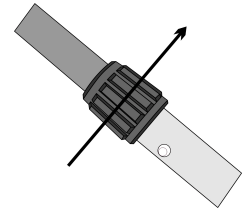

Winding the cable onto the handle prevents the cable from sliding down the stem. It is best to have a few centimetres of slack at the bottom of the stems, near the search coil, as this will prevent damage to the cable when the search coil changes its position (e.g. when the search coil hits the ground). Try to avoid creating large loops of cable near the edges of the search coil, as this may result in the detector giving false readings. The armrest cup is adjustable – first remove the screw, then move the cup to the desired position and re-tighten the screw.

NOTE: When disassembling the detector, begin by unplugging the search coil from the socket and loosen the cable wound around the stems. Once this is completed the rest of the detector may be disassembled into its basic components. Finish by loosening the screw securing the search coil and fold it together against the stem.

NOTE: The coil cable plug is protected by a silicon cover. This is there to prevent dirt and sand from damaging the delicate, gold connector pins. If the plug is not in the socket, it should **always** have the protective cover on.

## BATTERY INSTALLATION

Use good quality alkaline or rechargeable batteries of well known brands. Do not mix new and discharged batteries or regular ones with rechargeable ones. Used batteries must be removed from the detector as soon as possible. Remember to remove the batteries from the detector if it is not going to be used for an extended period of time. The warranty does not cover damage caused by leaking batteries damaging the electronics.

To install the batteries, first unlock the clip (1), next remove the lid (2) as shown in the picture. After pulling out the battery holder, insert the batteries as shown on holder, remember to check that the polarity is correct. The holder can only be inserted into the detector one way – the holder's socket construction prevents from inserting it the other way around.

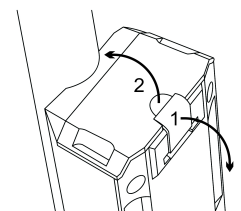

NOTE: The detector has a battery indicator which monitors the batteries' charge level. As the batteries lose charge, the indicator bar will shorten. When the batteries need replacing the detector will turn off automatically. It is not possible to turn on the detector if the batteries' charge is too low. As the battery reaches this level, the detector will make a sound of decreasing frequency and the display will show a symbol of a crossed out battery (see picture beside).



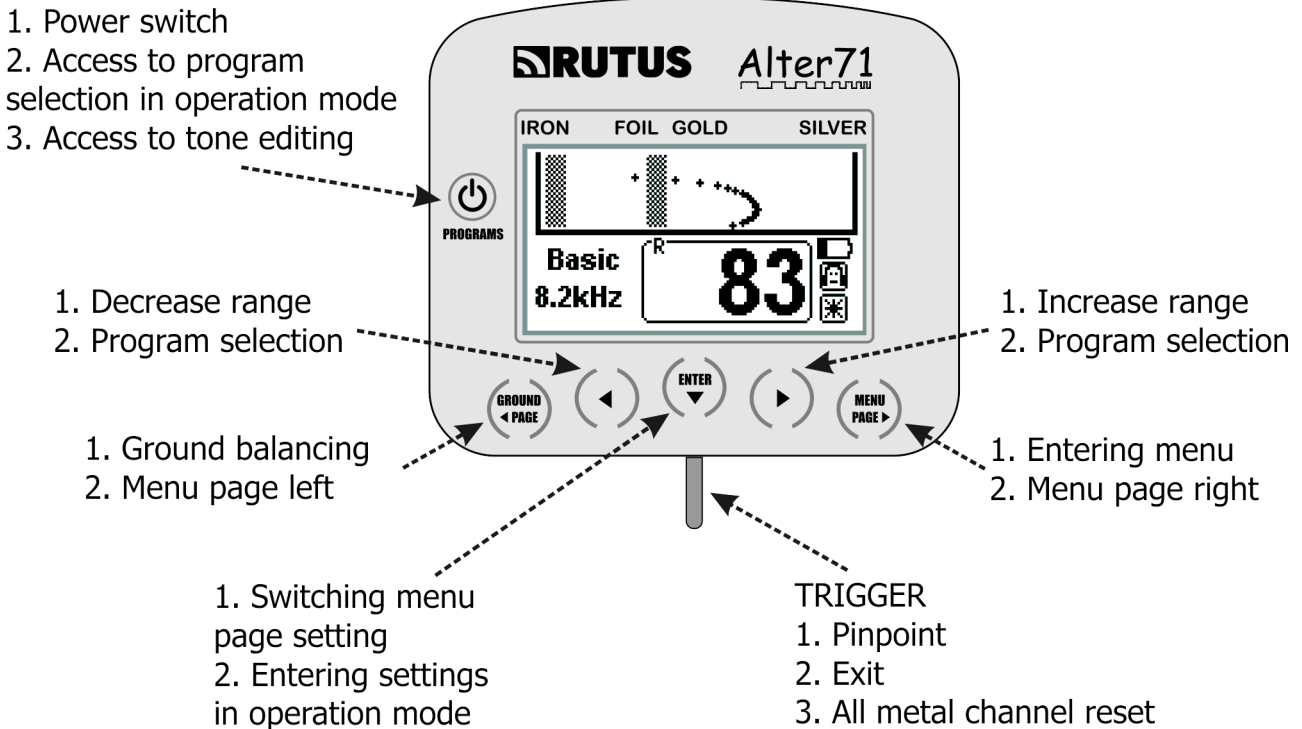

## CONTROL PANEL

The picture below shows the functions of individual buttons on the control panel.



## TURNING ON/OFF

The detector is turned on by pressing the button with the power icon. The detector can be turned off only from the operation mode by holding the  button for 1 second. In the menu the  button is used only to enter the tones editing screen. A short press of the button in the operation mode does not turn the detector off but changes to the program selection mode.

## GROUND BALANCE

After turning the detector on, the ground balance procedure must be completed. This can be done at any time by pressing the  button. When the message « Put search coil UP Then pull trigger » is shown, the search coil should be lifted at least 0.5 m above the ground, and then the trigger should be pulled. The display will then show the « Preparing Data » message, this means that the processor is collecting the data necessary for operation. After this process ends the « OK » message will appear followed by the main screen of ground balance (see picture below).

Correct ground balance is gained by „pumping“. The search coil should be slowly moved up and down above the ground, each cycle taking about a second. The detector will display the number of cycles remaining— decreasing from 5 to 1 and after the last movement up the message « Detector ready, pull trigger » will be shown. After pulling the trigger, the soil phase reading will be gathered and after about 2 seconds the detector will be ready for searching.

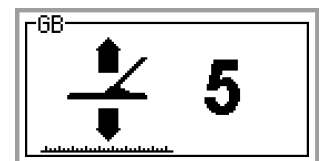

Most soil types gives a phase reading of around -87.0. Wetlands can produce higher phase readings (e.g. -83.0). Should the ground balance results be noticeably higher than these values (e.g. -75.0), there is a high probability that some metal objects are present in the balance area. The ground balance should be repeated again at a different location a few metres away.

Pulling the trigger, after the main ground balance screen is displayed, will start the detector using the factory settings. This is very useful if you want to find a clean place quickly, so that you can perform the ground balance process correctly using the „pumping” technique.

A single ground balance process does not guarantee stable operation across an entire search area or for the whole of a day's searching. It is best to repeat a ground balance process each time a new area is started or when the detector starts to give false readings. Examples of new areas would be where field changes to forest, or when moving from a track to wetlands.

The detector will also require a ground balance check when either the program, or the frequency of the hot rock parameters are changed.

NOTE: While data is being prepared for work (« Preparing Data » screen) the search coil must be raised a minimum of 0.5 m above the ground and away from metal objects. Ground balance must be done at least 15 m away from other detectors. Not following these guidelines will not damage the detector, but it will cause the detector to operate less accurately – a proper ground balance procedure will fix this quickly.

## DISPLAY

The picture below shows the display in the operation mode.

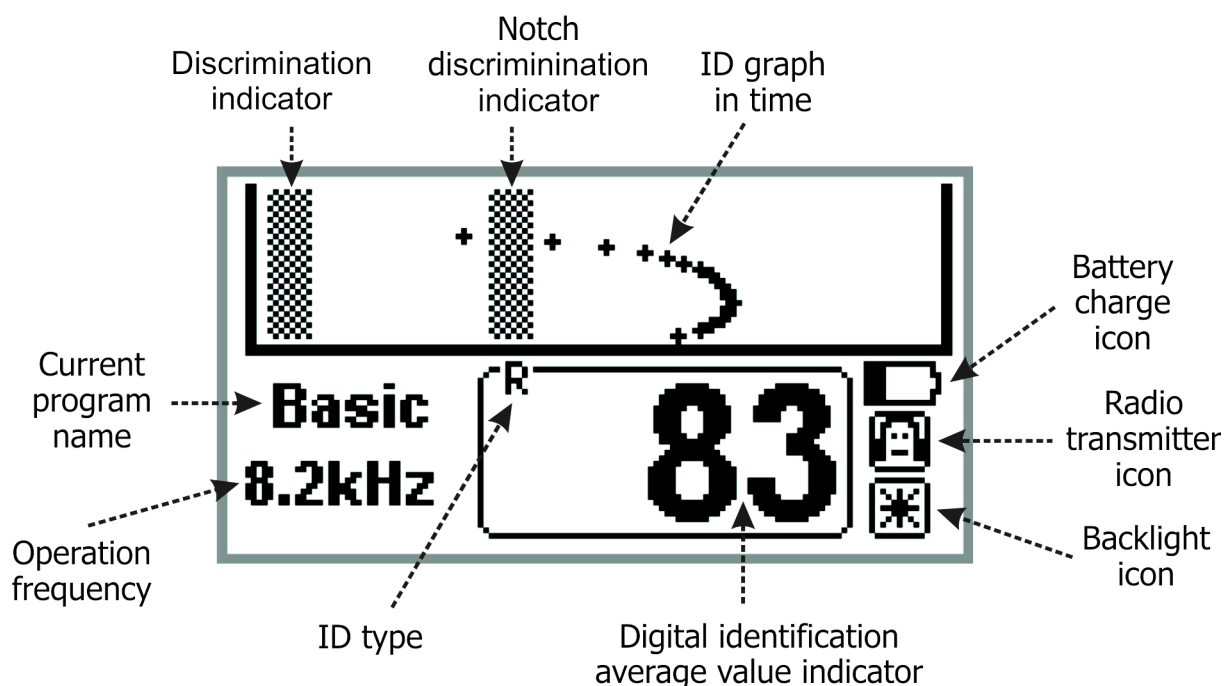

## PROGRAM SELECTION

The detector has 7 programs designed for various types of objects:



<b>Ultra deep</b>	A program to search for very large objects at great depth made of steel and non-ferrous metals. Classic non-motion mode without Discrimination and with graphic identification on display.
<b>Deep</b>	A program optimised for large steel objects at large depths.
<b>Big silver</b>	A program optimised for searching for big silver and copper coins.
<b>Basic</b>	A universal program. If you are not sure which program to choose, this is a good programme to start with.
<b>Coins</b>	A program to search for coins.
<b>Fast</b>	A fast program to search for coins and other small non-ferrous objects amongst steel junk.
<b>Ultra fast</b>	A very fast program to search for coins and other small non-ferrous objects amongst steel junk.



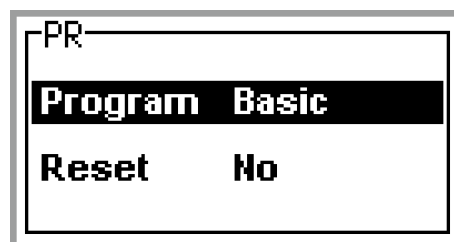

Each factory program can be modified to your own requirements, just enter the menu and change the settings shown. Modifications are stored after the power is switched off. If the changes are not what you expected, then they can be reset using the factory settings. Please find tables of these, and write your own settings at the back of this manual.

The programs save all the setting except for the following: Backlight, Discrimination, Sensitivity and Notch. These settings are saved by the detector after turning the power off but are independent of the programs. The reason for separating these four settings from the programs is so that they can be changed quickly, depending on the time of day and search conditions.

Turning the required program on is done by pressing the  button in the detector's operating mode. The program selection screen will appear:



The   buttons are used to select the program you would like, then press the trigger to enter the program. After changing a program a ground balance needs to be done, and the detector will guide you through this process.

If you want to reset a given program to the factory specifications, bring up the program selection screen (by pressing the  button) and use the  button to go down to the « Reset » option, then use the  button to choose « Yes ». Use the trigger to leave the program selection screen, the reset confirmation screen will then appear (« Really? »). Use the button  to select « Yes ». Use the trigger to complete, the chosen program will then be reset. Resetting a program to the factory settings does not result in resetting user sound profiles.

## IDENTIFICATION

Alter71 is a detector which has a built-in metal object identification circuit. The detector has 120 identification points. It analyses the signal from a metal object several hundred times per second, after each identification process, the internal memory of the device saves a specific digital value. The values stored in the memory are used to calculate an average identification value and an identification graph is shown. The average value depends on the characteristics of the object that is below the search coil.

When the search coil is moved over an object made of a ferrous metal (e.g. steel) the identification process will give a low value (e.g. 15). Non-ferrous metals will give higher identification values. The value for objects will depend on their size, thickness and the type of material they are made of. Small, thin objects give values of around 40 and big, thick ones, made from good conductors will show values above 100. The soil will also have an influence on the identification process. Rich mineral contents, and objects at great depth will influence the values against those taken from above the ground.

## IDENTIFICATION GRAPH

The identification graph is a graphical representation of the data collected by the identification circuit while moving the search coil over an object and is stored in the device's memory. This feature is unique to this detector, and allows for quicker identification of ferrous objects than any other method.

If the graph closely resembles a straight or inclined line then an object's composition is very likely to be of a single material and the digital identification has a high probability of being correct (a straight line in the range of iron is iron, a straight line in the range of non-ferrous metals is most probably a non-ferrous metal).

When the graph is clearly bent, curved or spread across the whole of the display, it is highly probable that you are dealing with an object such as a can, a thin steel sheet or other steel object whose magnetic properties are lesser than its conductive properties.

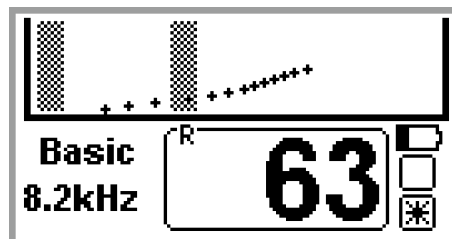
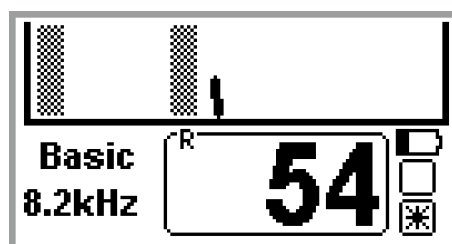



## SETTINGS AVAILABLE IN OPERATING MODE

Adjusting the Sensitivity level, Discrimination or access to the Notch function is done straight from the detector's operating mode. The way to access the settings is described below.

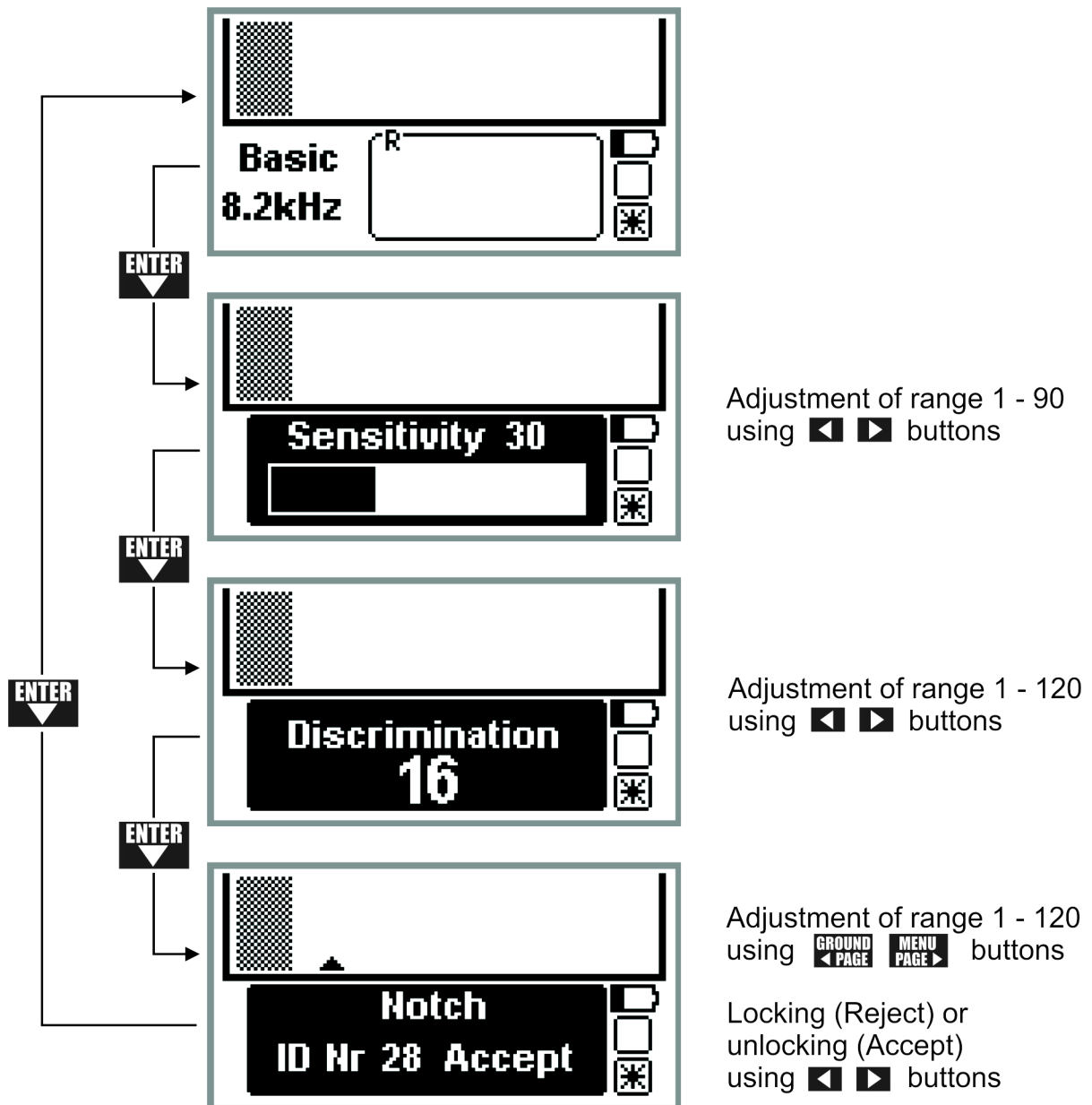

After pressing the **<ENTER>** button the « Sensitivity » message will appear on the display, a number describing the Sensitivity level and a linear scale showing the adjustment range. The adjustment is done using the **<Left>** **<Right>** buttons. Pushing the **<ENTER>** button a second time will show the Discrimination level. Adjusting the Discrimination is done in the same way as adjusting the Sensitivity.

Another press of the **<ENTER>** button will lead to the Notch function. The Notch point, which we want to lock (or unlock) is chosen using the **<Ground>** **<Menu>** buttons. The chosen Notch point is locked (Reject) or unlocked (Accept) using the **<Left>** **<Right>** buttons. After pressing the **<ENTER>** button the screen returns to the operation mode screen.

## **SENSITIVITY**

Sensitivity in the Alter71 detector may be adjusted across 90 levels. The Sensitivity level set by the user determines the detector's range and more importantly its stable operation. In areas which are littered, freshly ploughed or have heavy electromagnetic interference, operating with maximum Sensitivity is not possible. Sensitivity has to be adjusted in accordance to the terrain where the search is being conducted and using your own experience. New users should begin their searches with the detector set to Sensitivity levels between 40 and 60.

## **DISCRIMINATION**

Discrimination is a function which enables the removal of sound signals from unwanted objects, which have a identification number lower than the set Discrimination value. E.g. a Discrimination value set to 20 will result in a lack of the detector's reaction to most small steel objects. The Discrimination value can be set within the range 0 to 120.

## **NOTCH DISCRIMINATION**

The detector has 120 points of Notch function. Each of which can be locked individually. This function is used to eliminate signals from objects with a specific identification point, which helps to search in places where there is a large amount of similar, unwanted objects. For example, to eliminate signals from spent cartridges littering a battlefield but not eliminating signals from other objects.

To make best use of this function, block readings from the unwanted object's value, and a few points above and below this. The size of this range should be adjusted based on the search conditions. In places where identification readouts are stable, the range of the blocked signals should be as narrow as possible.

When using Notch it is important to remember that other objects with characteristics similar to the „unwanted“ ones will also be eliminated. For best results, only use this function in exceptional circumstances.

## PINPOINT

This function allows for the quick and easy location of an object. To use the pinpoint function move the search coil away from the area where the object is and then press and hold the trigger. The display will show two bars indicating the strength of the signal (see picture below). The upper bar shows the upper sensitivity reading, and the lower one shows the lower sensitivity. This allows the location of objects located at different depths. To pinpoint the object make a cross like movement, to find the point where the signal is the strongest.

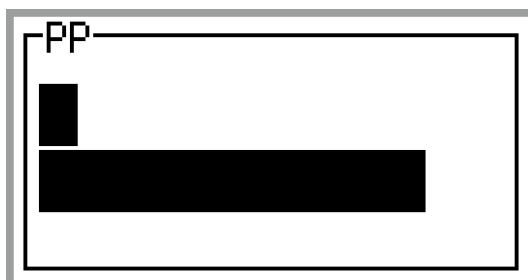

## OVERLOAD

An overload means that the signal from an object is too strong for the detector to process correctly. Thankfully this does not mean the detector has been damaged. An overload is indicated by a rattling sound and the « Overload » message on the display. In this situation lift the search coil up – when the overload message has gone, the display will show the identification value for the object.



# MENU LAYOUT

The menu is divided into three pages: Engine, Audio and Screen. This allows for clear and logical grouping of settings. To enter the Menu press the **MENU PAGE** button, and then press the trigger to leave. To switch between pages press the **MENU PAGE** button and then switch between the settings on each individual page by pressing the **ENTER** button.

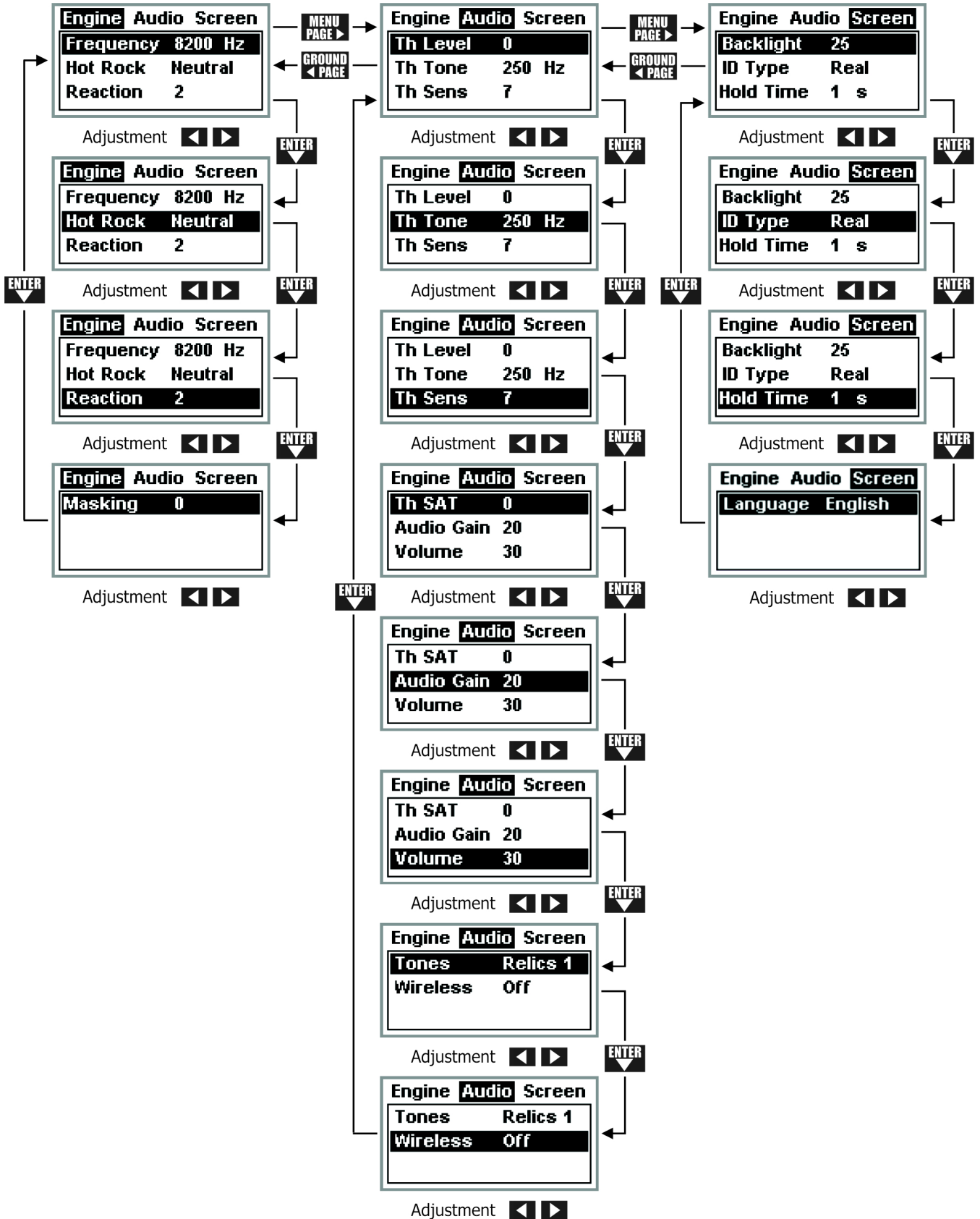

## MENU - ENGINE PAGE

Setting	Adjustment range
Frequency	4400 – 18400 Hz
Hot Rock	-30 – 30
Reaction	1 – 8
Masking	0 – 6

The **Engine** page contains the following settings:

### Frequency

Alter71 has another unique feature, it can be tuned across a very broad spectrum of frequencies. It is possibly the first entry level metal detector which may be tuned from 4.4 kHz to 18.4 kHz with steps of 0.2 kHz. The user can choose one of 71 available frequencies to work with. The tuning is done using the ◀ ▶ buttons.

The choice of frequency used has a very big impact on the detector's ability to detect objects. The general rule is: the smaller the object, the higher frequency used. Frequency also influences the quality of Discrimination of flat shaped steel objects, the higher the frequency, the more the properties of the metal sheets resemble those of non-ferrous metals. The frequency also has an influence on the power consumption of the device. The operating time at 4.4 kHz is much shorter than at 18.4 kHz. If you are not sure which frequency to work with – use 8 kHz.

<b>4.4 – 6.4 kHz</b>	Deep searches for highly conductive objects e.g. large non-ferrous metal parts, large silver coins or large steel objects
<b>6.6 – 10 kHz</b>	Universal search
<b>Above 10 kHz</b>	To search for small, thin objects

### Hot rock

This adjustment allows the detector's reaction to magnetic rocks and objects of particularly high identification value to be modified. Magnetic rocks are plain field rocks which have residual magnetic properties. Magnets do not attract them, but they influence the detector's operation. They are essentially recognized by the detector as signals with an ID value of 0 and in most cases these objects can be isolated using the Discrimination option, in the same way as simple steel scrap. Objects with exceptionally high ID values (119 or 120) are large pieces of aluminium, aluminium sheets and aluminium canteens. In this way Hot rock adjustment can be used to set the reaction to objects at both ends of the identification scale. This is a result of the detector „virtually“ connecting both ends of the scale. The microprocessor does not treat the identification scale as linear, but rather circular, where values of 0 and 120 are connected, and therefore an object identified as above 0 is automatically identified as a high value object and vice versa.

Hot rock adjustment is simply a slight tuning of the circular scale on which the detector's operation is based. In this way magnetic rocks can be set apart from the 0 value and will be more clearly discriminated (but equally the aluminium canteens will fall into the 0 value and thus are also discriminated). It is equally possible to adjust the values in the other direction: moving the large aluminium objects to lower identification values (e.g. 118) and in this way increase the effectiveness of detecting these kind of objects but this may result in magnetic rocks giving a high, fuzzy tone. The factory setting for magnetic rocks correction is set to Neutral and this is the best setting for 99% of search areas. But if for some reason there is a need to increase the masking of magnetic rocks, use the  button to set it to negative values. The adjustment of values into the positive range will increase the detection range for canteen in the Motion mode.

## Reaction

This adjustment gives the ability to select the speed of soil filtering. It is an essential factor in the ability to detect large, deeply placed objects, the speed of detection and its resistance to soil mineral contents.

<b>Filters 1 – 2</b>	Used to search for large objects. It can, on occasion, be used to search for large coins in lightly mineralised soil (sand).
<b>Filter 3</b>	A universal setting, if you are not sure which filter to use – choose this one
<b>Filter 4 – 8</b>	Increasingly quicker filters should be used for searching of small, thin objects amongst steel junk

## Masking

This setting is used to adjust the masking of short signals in the detector's speaker. These signals come from the partially discriminated signals of bottle caps, iron, magnetic rocks, junk etc. Masking improves the quality of Discrimination. For a zero Masking value, the detector will give produce a tone for all signals, even the shortest ones. Some small steel junk will be hard to discriminate, the detector will be „noisy“ during a search.

As the Masking value increases the operation of the detector becomes less „noisy“ and it becomes possible to search for non-ferrous metal objects amongst iron junk. Some may assume that Masking should always be set to the highest value, but this is not the case – high Masking settings can cause a lack of signal for objects on the borders of the range. In clear terrain, if the user wants to reach as deep as possible, the Masking value should be set as low as possible.

For each value of the Reaction parameter there is a maximum level of the Masking parameter, above which the detector will fail to work correctly. The software detects this and will automatically (upon exiting the Menu) correct the Masking setting value if this occurs.

<b>Reaction</b>	Maximum possible Masking value	<b>Reaction</b>	Maximum possible Masking value
<b>1</b>	6	<b>5</b>	4
<b>2</b>	6	<b>6</b>	4
<b>3</b>	6	<b>7</b>	3
<b>4</b>	5	<b>8</b>	2

## MENU - AUDIO PAGE

<b>Setting</b>	<b>Adjustment range</b>
Th Level	0 – 100
Th Tone	60 – 500
Th Sens	0 – 30
Th SAT	0 – 20
Audio Gain	0 – 60
Volume	1 – 30
Tones	Coin 1, 2, 3; Relics 1, 2, 3; User 1, 2, 3
Wireless	Off, Ch 1, Ch2

The **Audio** page contains the following settings:

### Th Level

The Threshold is the background sound which is always heard while the detector is active. It can be increased or decreased depending on the user's preferences and the level of noise at the search site. The level of the Threshold should be set so that it is only slightly audible – in this way you can be sure that you will hear even the quietest signals from objects. The Threshold is very important – it enables the All metal channel to be correctly reset by the user.

### Th Tone

The Th Tone should be set as you wish – each user will have their own preferences as to the sound frequency which is the most appropriate.

### Th Sens

The Th Sens regulates the level of the Threshold from the All metal channel. This allows the operation mode to be modified. When a Th Sens setting of 0 is used the detector becomes dynamic, but for higher levels the influence of the All metal channel on the level of the Threshold is also higher. For Th Sens settings above 10, the detector switches to Dual mode.

## Th SAT

The Th SAT function reduces the effects of external conditions on the operation of the All metal channel of the detector. To put it simply: by using this setting we can prevent the detector mistuning in the sun. Another important function of SAT is changing the response of the All metal channel. For high SAT settings (especially SAT = 20) the user has the ability to audibly differentiate between a large number of small objects laying at a shallow depth from one big object. A setting of 0 means that the Th SAT circuit is completely turned off, a setting of 20 is the maximum speed available.

NOTE: Turning the Th SAT circuit on can result in a decrease in the range of the detector's All metal channel. The amount of range loss will depend on the speed at which the search coil is moved.

## Audio Gain

The Audio Gain adjustment changes how detected objects are signalled. A small Audio Gain will mean that weak signals from the Motion channel will have a quiet sound and strong signals, a loud sound. This provides „depth“ in the form of sound, which allows us to hear how far from the search coil an object is located. If you set the Audio Gain to the maximum value then all signals will produce a tone of maximum loudness.

At an Audio Gain setting of 0, the sounds from the Motion channel are completely blocked. This means that only sounds from the All metal channel are heard, while looking at the ID value of an object on the display. For this setting the VCO function is automatically turned on – as the power of the signal increases both the loudness of the sound and its frequency increases too. It is important to use the detector completely still.

NOTE: Remember not to set both the Audio Gain and Th Sens to 0 as this will turn off the detector's sound signals completely.

## Volume

To adjust the volume of the sound received from objects. The level of the Threshold is not dependent on this setting.

## Tones





The user has 9 sound profiles in the Motion channel from which to choose. They are divided into three groups:

1. Coins: 1, 2, 3
2. Relics: 1, 2, 3
3. User: 1, 2, 3

NOTE: We strongly recommend using one of the Coins profiles to search for coins and other small objects made of non-ferrous metals.



<b>Coins and Relics profiles</b>	Factory set profiles, which cannot be edited by the user (although they may be previewed – by pressing a button)
<b>User profiles</b>	These allow for sound personalization and can be edited – any tone between the range of 60 to 999 Hz can be assigned to one of the 120 identification points

After selecting a suitable sound profile from the User group it can be edited by pressing the  button. The   buttons are used to choose the ID number for which a specific tone is applied and the   buttons are used to change the frequency of the sound. The ID number currently edited is shown by a digit and a cursor (a filled triangle for the Copy mode and an empty one for the Normal mode) which are shown at the bottom of the display.

The tone editing screen can be displayed in two modes – the Normal mode and the Copy mode. Choosing a mode is done by pressing the  button. Changing the cursor's position (a filled triangle) in the Copy mode results in copying the tone value from an adjacent ID position, the one the cursor was previously on. In this way it is possible to quickly set the same tone to a whole group of ID numbers.

In the Normal mode changing the cursor's position (an empty triangle) does not copy the value of an adjacent ID position. In this way it is possible to set a sound tone individually for each ID number and, if needed, listen to the whole sound profile.

Changes are saved after switching off the detector's power supply.

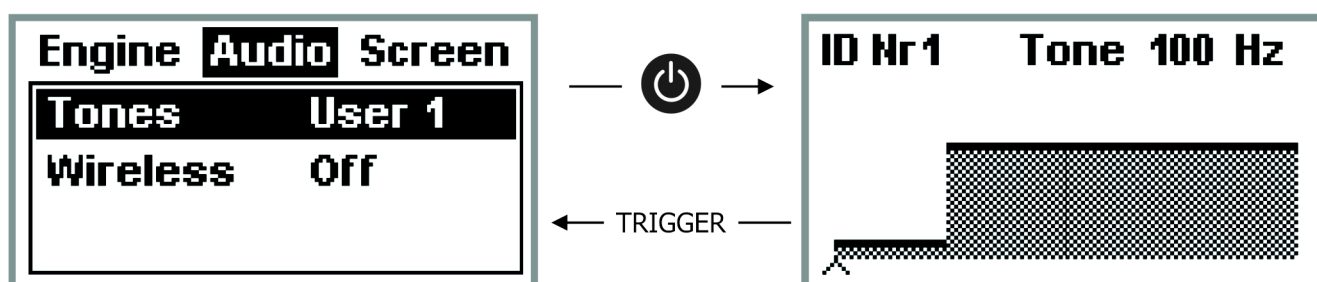

Setting the tone's ID number



Setting the tone's frequency



Selecting between Normal mode and Copy mode

## Wireless

Alter71 has a built-in wireless digital data transmitter which can work on one of two available radio frequencies. The design of the digital connection was made especially for our detectors – therefore there is no lag or background noise. The use of the accompanying wireless devices is detailed in their respective user's manuals.

<b>OFF</b>	The transmitter is off, the built-in speaker and headphone's socket are active
<b>Ch 1, Ch 2</b>	The transmitter is on, the detector's sound generating circuit is off

<b>Setting</b>	<b>Adjustment range</b>
Backlight	0 – 29
ID Type	Real, At 6kHz, At 12 kHz
Hold Time	1 – 10
Language	Polski, English *

\* The manufacturer reserves the right to add additional menu languages without notice

The **Screen** page contains the following settings:

### **Backlight**

Adjustment of the display's backlight. This allows searching in low light conditions.

### **ID Type**

Identification of the type of object depending on the frequency. As the operation frequency of the detector changes, the ID value of non-ferrous objects increases and the ID value of ferrous objects is subjected to much more complex rules. It is difficult to memorize the IDs of different objects if the user has a total of 71 frequencies to choose from. This is the reason the detector has the ability to calculate the IDs to standard values for two frequencies: 6 kHz and 12 kHz or to present the Real ID.

While searching for small objects on high frequencies we suggest using the function of calculating the ID for 12 kHz – this way it is easy to recognize small differences in ID values between a foil and the desired objects. In other cases we suggest using the function of calculating the ID for 6 kHz. The use of the Real ID function is advised only for experienced users.

### **Hold Time**

This function allows adjustment to the time that the screen shows information. In clear terrain we suggest using the high values, for littered areas the lower ones are recommended.

### **Language**

Allows the menu language to be chosen.

## DETECTOR'S CAPABILITIES

To understand how Alter71 works and its potential, the device's flow chart below will help:

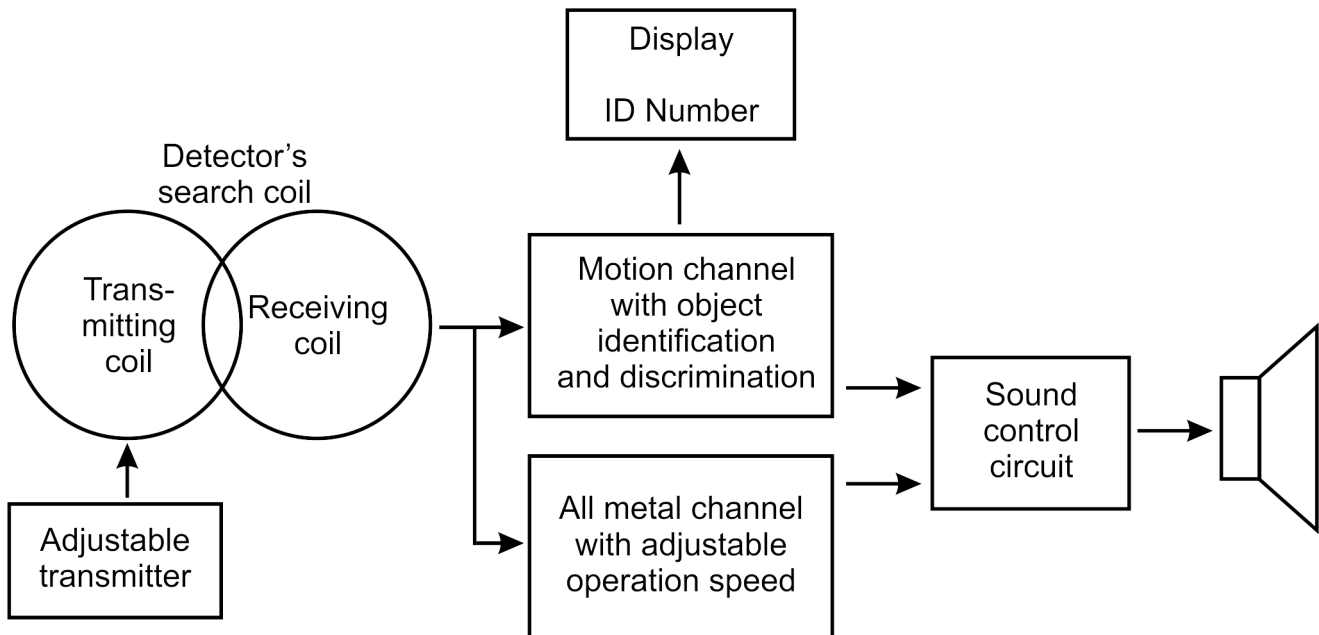

Alter71 consists of several basic functional blocks: a transmitter, a search coil, a Motion Channel, an All metal channel, a sound control circuit and parts used to communicate with a user: a display and a speaker.

The transmitter controls the transmitting coil in the search coil and its operating frequency can be adjusted from 4.4 kHz to 18.4 kHz. The signal from the search coil's receiving coil (after processing, not taken into consideration in the chart above) is directed simultaneously through two channels:

1. Motion channel with object identification and Discrimination
2. All metal channel with adjustable operation speed

Signals processed in both channels are directed to the sound control circuit.

The Motion channel with object identification and Discrimination ensures the objects are properly identified. The identification result is directed to the display independently of the sound control circuit, but the sound signal is directed to the sound control circuit only when it is allowed by the Discrimination, Notch or Masking settings. The Motion channel – as its name suggests – requires that the search coil be moved relatively to the object.

The All metal channel reacts to all metal objects or, depending on the soil category (using data from ground balance) and SAT setting, can react to magnetic objects under certain conditions (so called hot rocks, ceramics, bricks etc. and objects other than the soil).

The All metal channel can be completely non-motion (SAT = 0) or it may require the movement of the search coil as the SAT parameter is increased. When SAT is set to 20, the All metal channel works as a „single-filter“ Motion channel – where movement is required.

The sound control circuit chooses which signal to send to the speaker at a given moment:

– when Th Sens is set to 0, the sound from the All metal channel is blocked.

As this parameter is increased, the sensitivity (and also range) of the All metal channel is increased;

– when the Audio Gain is set to 0, the sound from the Motion channel with objects identification and Discrimination is blocked. Higher values allow the sound to be passed to the speaker.

In the sound control circuit, the Motion channel with objects identification and Discrimination has priority over the All metal channel. In this way it is possible to hear the presence of all the objects (from the All metal channel) and interruptions from the Motion channel, if an object is accepted by Discrimination.

## MODES OF OPERATION

This design allows the detector to work in several modes of operation:

1. Motion mode with Discrimination – a classical detector.
2. All metal Non-motion – a mode used to search for large objects.
3. All metal Motion („single-filter”) – a mode which allows large objects to be found but with the ability to separate many small objects on the surface of the ground.
4. Dual mode – Motion mode with Discrimination + All metal with any speed setting.

An important part of operating the detector is to understand the characteristics of the basic modes of operation.

### 1. Motion mode with discrimination

In this mode the movement of the search coil relative to the metal object is necessary. The mode is selected by setting the Th Sens to 0 and Audio Gain above 0. This gives the ability to set individual sound tones for each ID position (from 1 to 120) or use the preset sound profiles. In this mode both identification and Discrimination work.

#### Discrimination

This is the ability to block sound signals for objects with conductivity (ID) lower than the set value. The Discrimination scale starts with iron and goes through foil, gold and ends with silver. A Discrimination level set to 30 allows searches without detecting ferrous objects. Naturally, there will be times when the detector will signal the presence of large ferrous objects as „non-ferrous” objects. It is generally recognized that Discrimination works best for small objects at shallow depths.

NOTE: When searching for coins and other small non-ferrous objects we recommend: Coins group sound profiles and setting the Discrimination level to above 20.

## Notch

This type of Discrimination allows for selective operation – the user can choose which types of objects will be indicated and which will not be.

## Identification

This function is described on page 7. In practice it allows for the non-standard use of the motion operation – one can usually setting the Discrimination to 0 and not using Notch. The detector will use sound to signal all metal objects, on the basis of the sound and the indications on the display, the user will be able to recognize all the objects in the soil. In this way the user is aware of the conditions in which they are performing the search. If using Discrimination in the Motion mode, they may not have a full view of the situation and would not be aware of how many metal objects are littering an area.

NOTE: While operating in the Motion mode with Discrimination, the trigger is used to initiate the pinpoint option.

## **2. All metal Non-motion**

This operating mode requires the search coil to be stationary. It works when the Audio Gain and SAT are set to 0, while the Th Sens is set above 0. The detector signals all metal objects using the sound channel. The volume and the tone of the sound, depends on the signal's strength – this gives the user information about the object's size and distance from the search coil.

When using a detector which has been well ground balanced, and by using the Th Level setting at 0 a sound signal will be received from a metal object. The only way of identifying an object is by checking the information shown on the display. **The key characteristic of this mode is that it provides the maximum detection range for all metal objects in the ground.**

NOTE: In this operating mode it is important to reset the All metal channel, this needs to be done away from metal objects. For best operation in non-motion mode, listen to the Threshold, this should be set so that it can be heard. If the Threshold becomes inaudible then a reset is required, equally if the detector suddenly starts creating a loud sound with no apparent reason, then reset the channel.

## **3. All metal Motion**

This All metal mode needs the search coil to be moved, for it to work the Audio Gain should be set to 0, while the Th Sens and SAT are set above 0.

As for the All metal non-motion mode, the detector uses sound to signal all metal objects. When the search coil is stopped in close proximity to a metal object, the detector will automatically „tune“ itself to the metal and stop signaling the object. How long this takes will depend on the SAT value: if SAT is set to 1 then this will be 1 second, if SAT is set to 20 – it will be approximately 0.7 seconds.

Under certain conditions, and depending on the ground balance, the detector may react to non-metallic objects. Hot rocks and other objects which have properties which are not similar to soil, may create a sound signal. An experienced user will have no problem differentiating these signals from normal signals as they have very different characteristics. The only way to identify the conductivity of these metals is to check the ID readouts on the display. The All metal Motion mode has greater range than the Motion mode with Discrimination.

NOTE: When listening to deeply placed objects it is a common mistake to swing the search coil too quickly over an object. After the search coil passes over an object and emits a sound, the Threshold will be turned down. To confirm an object has been located it is important to wait for the Threshold to return to its original level. This time can be shortened by resetting the All metal channel using the trigger.

#### **4. Dual mode**

This mode combines the Motion mode with Discrimination and the All metal mode. It is done by setting both the Th Sens and Audio Gain above 0. This combination provides the advantages of both modes – identification coming from the Motion channel and the maximum range of the All metal channel. To better understand the characteristics of the Dual mode it is best to get to know all of the other modes first before starting to use this mode.

### **MODES OF OPERATION AND SEARCHING**

When beginning to decide which mode to use for searching, it is best to follow a few simple rules. These are only initial rules as those with a little more experience will be able to select the most appropriate for particular situations and object types.

Typical use of operation modes:

1. To search for small objects in fields, the optimal modes will be the Motion ones (with Discrimination and All metal). The correct mode will depend on the user's expectations, if the user wants to search only for clear signals from non-ferrous metal objects, Motion with Discrimination is best. If the user wishes to find all kinds of small objects, All metal Motion mode will be better.
2. To search for large objects at depth, the Non-motion mode is the best.
3. For universal searches the Dual mode will be the best.

Incorrect modes:

1. Non-motion mode will be very poor when searching for small objects in highly littered area.
2. Motion mode with Discrimination (especially for Reaction set above 2) will not give good results when searching for very large, deeply located objects or to conduct search in places where the movement of the search coil is impossible e.g. very dense bushes, or holes.

As your knowledge of the particular characteristics of this detector increases it will become easier to choose the best mode for each terrain and searching task.

## SEARCHING - USEFUL ADVICE

Searching is done by sweeping the search coil left and right as quickly as is comfortable and as close to the ground as possible. The exception to this rule is when searching for large objects using low Reaction values (1 or 2) – in this case it is best to keep the search coil 20 cm above the ground. Touching the ground with the search coil should be avoided, try to avoid hitting it against rocks and other objects protruding from the ground. While the search coil is designed to be resistant to damage when hit against hard objects, a more effective search will be had if this can be avoided.

The search coil should be held parallel to the ground, as this is very important to ensure an effective search. This is especially important when reaching the end of each left and right swinging motion, as lifting here changes the distance from the ground. This changes the level of the soil signal, which results in the filters having to process this, giving a decrease in search efficiency. Over time try to get into the habit of moving the search coil parallel to the ground.

How fast you are able to search depends on your ability to sweep, however sweeping too fast can cause a drop in effectiveness also, especially in very littered terrain. In Motion mode with Discrimination, swinging the search coil too slowly will also decrease the effectiveness, especially at higher Reaction values. For these reasons sweeping should be no slower than 0.3 m/s and no faster than 1.5 m/s.

To achieve the most accurate identification of a tiny object, the centre of the search coil should move exactly over the buried object. To do this, use the Pinpoint function, start by moving the search coil 40 – 50 cm away from the location where the object was first identified. Lift the coil slightly and then pull the trigger, then move the coil back to the area where the object was detected and try pinpointing its exact location with the strongest signal.

After determining where the object is buried, release the trigger and, while remembering where the middle of the signal is, swing the search coil so that its middle moves over the object, in quick, short movements of between 40 – 50 cm. This will confirm that the detected signal is in the middle of the search coil – and not at its edge – which could cause false identification.

It is recommended to use headphones with this detector, as they will help in shielding external noise. This will allow you to listen more closely to detector's weakest signals, increasing the technical capabilities, especially in All metal modes, where the sounds are more subtle. When searching for the deepest objects, headphones should be an essential part of your equipment.

## NOTES FOR MAINTENANCE

- ! The detector must be turned off before exchanging the search coil.
- ! The device must not be stored with depleted regular or rechargeable batteries installed. When the device is to be stored for more than a month, the cells must be removed regardless of their charge status.
- ! The detector must not be subjected to high temperatures – leaving the detector on a hot day in a car may damage it.
- ! Do not store the detector in an unheated room during the winter. The best place to store the detector is in a dry room, at room temperature.
- ! The search coil is waterproof to a depth of 1m, the detector electronics are not waterproof.
- ! Cleaning the detector must be done using only water with soap on a damp sponge. Do not use any solvents or petroleum products. Regularly clean the stems and clamps.
- ! If you use wired headphones – remove the plug from the headphone socket at the end of each search as transporting a detector with the plug plugged in increases the risk of damaging the socket.
- ! In difficult weather conditions it is advised to use a cover for the control panel and the battery compartment.
- ! Correct maintenance of the detector will increase its reliability and longevity.

## PROGRAMS SETTINGS

Ultra deep						Deep					
Page	Setting	Factory value	My changes	My changes	My changes	Page	Setting	Factory value	My changes	My changes	My changes
Engine	Frequency	5000 Hz				Engine	Frequency	7000 Hz			
Engine	Hot rock	+10				Engine	Hot rock	+5			
Engine	Reaction	1				Engine	Reaction	2			
Engine	Masking	6				Engine	Masking	4			
Audio	Th Level	30				Audio	Th Level	5			
Audio	Th Tone	100 Hz				Audio	Th Tone	150 Hz			
Audio	Th Sens	30				Audio	Th Sens	30			
Audio	Th SAT	5				Audio	Th SAT	5			
Audio	Audio Gain	0				Audio	Audio Gain	20			
Audio	Volume	30				Audio	Volume	30			
Audio	Tones	Relics 3				Audio	Tones	Relics 3			
Screen	ID Type	6 kHz				Screen	ID Type	6 kHz			
Screen	Hold Time	5 s				Screen	Hold Time	5 s			



**Big silver**

Page	Setting	Factory value	My changes	My changes	My changes	Page	Setting	Factory value	My changes	My changes	My changes
Engine	Frequency	5000 Hz				Engine	Frequency	8000 Hz			
Engine	Hot rock	+10				Engine	Hot rock	0			
Engine	Reaction	3				Engine	Reaction	3			
Engine	Masking	3				Engine	Masking	4			
Audio	Th Level	10				Audio	Th Level	0			
Audio	Th Tone	250 Hz				Audio	Th Tone	150 Hz			
Audio	Th Sens	25				Audio	Th Sens	0			
Audio	Th SAT	10				Audio	Th SAT	0			
Audio	Audio Gain	20				Audio	Audio Gain	20			
Audio	Volume	30				Audio	Volume	30			
Audio	Tones	Coin 3				Audio	Tones	Coin 3			
Screen	ID Type	6 kHz				Screen	ID Type	6 kHz			
Screen	Hold Time	5 s				Screen	Hold Time	5 s			

**Basic****Coins**

Page	Setting	Factory value	My changes	My changes	My changes	Page	Setting	Factory value	My changes	My changes	My changes
Engine	Frequency	15000 Hz				Engine	Frequency	18000 Hz			
Engine	Hot rock	0				Engine	Hot rock	0			
Engine	Reaction	4				Engine	Reaction	6			
Engine	Masking	4				Engine	Masking	3			
Audio	Th Level	0				Audio	Th Level	0			
Audio	Th Tone	250 Hz				Audio	Th Tone	250 Hz			
Audio	Th Sens	0				Audio	Th Sens	0			
Audio	Th SAT	0				Audio	Th SAT	0			
Audio	Audio Gain	20				Audio	Audio Gain	20			
Audio	Volume	30				Audio	Volume	30			
Audio	Tones	Coin 3				Audio	Tones	Coin 1			
Screen	ID Type	12 kHz				Screen	ID Type	12 kHz			
Screen	Hold Time	5 s				Screen	Hold Time	5 s			

**Fast****Ultra fast**

Page	Setting	Factory value	My changes	My changes	My changes	My changes	My changes	My changes	My changes	My changes	My changes
Engine	Frequency	18000 Hz									
Engine	Hot rock	0									
Engine	Reaction	8									
Engine	Masking	2									
Audio	Th Level	0									
Audio	Th Tone	250 Hz									
Audio	Th Sens	0									
Audio	Th SAT	0									
Audio	Audio Gain	20									
Audio	Volume	30									
Audio	Tones	Coin 1									
Screen	ID Type	12 kHz									
Screen	Hold Time	5 s									

## EU DECLARATION OF CONFORMITY



Manufacturer: RUTUS Arkadiusz Rutyna, ul. Krakowska 32, 84-230 Rumia, Poland

Product: Metal detector Alter71

The manufacturer hereby states that this product is in accordance with the requirement of Directive 2014/30/UE on the harmonization of the laws of the Member States relating to electromagnetic compatibility with all later amendments and supplements as it meets the requirement of the following harmonised norms:

PN-EN 61000-4-2:2011

PN-EN 61000-4-3:2007 + A1:2008+A2:2001

PN-EN 61000-4-8:2010

PN-EN 6100-6-3:2008 + A1:2012

Test report no. 086/LMC/2016 from 16.08.2016.

This test was conducted at Laboratorium Badawcze Oddziału Instytutu Elektrotechniki (Institute of Electronics Research Laboratory) in Gdańsk, which is accredited by PCA in the area of tested product and owns an accreditation certificate no. AB007.

This declaration conformity is issued under the sole responsibility of the manufacturer.

**RUTUS Arkadiusz Rutyna**  
**ul. Krakowska 32**  
**84-230 Rumia**  
**Poland**  
**tel. + 48 58 679 33 14**  
**+ 48 601 284 371**  
**rutus@rutus.com.pl**  
**www.rutus.com.pl**

The symbol of a crossed out dustbin means that the product cannot be disposed of with household waste. It is the user's responsibility to take the used equipment to a waste disposal site which has the facilities to handle electrical and electronic equipment. By ensuring this equipment is handled correctly you help to protect the environment. For more information about how to recycle this product please contact your local authority, waste removal provider or the shop where this product was purchased.

